



**User Manual**

Oven

EN

**KODEC60X**



 **Electrolux**

## WE'RE THINKING OF YOU

Thank you for purchasing an Electrolux appliance. You've chosen a product that brings with it decades of professional experience and innovation. Ingenious and stylish, it has been designed with you in mind. So whenever you use it, you can be safe in the knowledge that you'll get great results every time.

Welcome to Electrolux.

Visit our website to:



Get usage advice, brochures, trouble shooter, service and repair information:  
[www.electrolux.com/support](http://www.electrolux.com/support)



Register your product for better service:  
[www.registerelectrolux.com](http://www.registerelectrolux.com)



Buy Accessories, Consumables and Original spare parts for your appliance:  
[www.electrolux.com/shop](http://www.electrolux.com/shop)

## CUSTOMER CARE AND SERVICE

Always use original spare parts.

When contacting our Authorised Service Centre, ensure that you have the following data available: Model, PNC, Serial Number.

The information can be found on the rating plate.

 Warning / Caution-Safety information

 General information and tips

 Environmental information

Subject to change without notice.

## CONTENTS

1. SAFETY INFORMATION.....	3
2. SAFETY INSTRUCTIONS.....	4
3. PRODUCT DESCRIPTION.....	7
4. CONTROL PANEL.....	8
5. BEFORE FIRST USE.....	8
6. DAILY USE.....	9
7. CLOCK FUNCTIONS.....	11
8. USING THE ACCESSORIES.....	12
9. ADDITIONAL FUNCTIONS.....	13
10. HINTS AND TIPS.....	13
11. CARE AND CLEANING.....	26
12. TROUBLESHOOTING.....	29
13. ENERGY EFFICIENCY.....	30
14. SAUDI ARABIA - CUSTOMER SERVICE.....	31
15. ENVIRONMENTAL CONCERNS.....	31

## 1. ⚠ SAFETY INFORMATION

Before the installation and use of the appliance, carefully read the supplied instructions. The manufacturer is not responsible for any injuries or damage that are the result of incorrect installation or usage. Always keep the instructions in a safe and accessible location for future reference.

### 1.1 Children and vulnerable people safety

- This appliance can be used by children aged from 8 years and above and persons with reduced physical, sensory or mental capabilities or lack of experience and knowledge if they have been given supervision or instruction concerning the use of the appliance in a safe way and understand the hazards involved. Children of less than 8 years of age and persons with very extensive and complex disabilities shall be kept away from the appliance unless continuously supervised.
- Children should be supervised to ensure that they do not play with the appliance.
- Keep all packaging away from children and dispose of it appropriately.
- **WARNING:** The appliance and its accessible parts become hot during use. Keep children and pets away from the appliance when in use and when cooling down.
- If the appliance has a child safety device, it should be activated.
- Children shall not carry out cleaning and user maintenance of the appliance without supervision.

### 1.2 General Safety

- This appliance is for cooking purposes only.
- This appliance is designed for single household domestic use in an indoor environment.
- This appliance may be used in, offices, hotel guest rooms, bed & breakfast guest rooms, farm guest houses and other

similar accommodation where such use does not exceed (average) domestic usage levels.

- Only a qualified person must install this appliance and replace the cable.
- Do not use the appliance before installing it in the built-in structure.
- Disconnect the appliance from the power supply before carrying out any maintenance.
- If the supply cord is damaged, it must be replaced by the manufacturer, its Authorised Service Centre or similarly qualified persons to avoid an electrical hazard.
- The means for disconnection must be incorporated in the fixed wiring in accordance with the wiring rules.
- **WARNING:** Ensure that the appliance is switched off before replacing the lamp to avoid the possibility of electric shock.
- **WARNING:** The appliance and its accessible parts become hot during use. Care should be taken to avoid touching heating elements or the surface of the appliance cavity.
- Always use oven gloves to remove or insert accessories or ovenware.
- To remove the shelf supports first pull the front of the shelf support and then the rear end away from the side walls. Install the shelf supports in the opposite sequence.
- Do not use a steam cleaner to clean the appliance.
- Do not use harsh abrasive cleaners or sharp metal scrapers to clean the glass door since they can scratch the surface, which may result in shattering of the glass.

## 2. SAFETY INSTRUCTIONS

### 2.1 Installation

 **WARNING!**

Only a qualified person must install this appliance.

- Remove all the packaging.
- Do not install or use a damaged appliance.

- Follow the installation instructions supplied with the appliance.
- Always take care when moving the appliance as it is heavy. Always use safety gloves and enclosed footwear.
- Do not pull the appliance by the handle.
- Install the appliance in a safe and suitable place that meets installation requirements.
- Keep the minimum distance from other appliances and units.

- Before mounting the appliance, check if the appliance door opens without restraint.
- The appliance is equipped with an electric cooling system. It must be operated with the electric power supply.
- The built-in unit must meet the stability requirements of DIN 68930.

Cabinet minimum height (Cabinet under the worktop minimum height)	578 (600) mm
Cabinet width	560 mm
Cabinet depth	550 (550) mm
Height of the front of the appliance	594 mm
Height of the back of the appliance	576 mm
Width of the front of the ap- pliance	595 mm
Width of the back of the ap- pliance	559 mm
Depth of the appliance	567 mm
Built in depth of the appli- ance	546 mm
Depth with open door	1027 mm
Ventilation opening mini- mum size. Opening placed on the bottom rear side	560x20 mm
Mounting screws	4x25 mm

## 2.2 Electrical connection

### **WARNING!**

Risk of fire and electric shock.

- All electrical connections should be made by a qualified electrician.
- The appliance must be earthed.
- Make sure that the parameters on the rating plate are compatible with the electrical ratings of the mains power supply.
- Always use a correctly installed shockproof socket.
- Do not use multi-plug adapters and extension cables.
- Make sure not to cause damage to the mains plug and to the mains cable. Should the mains cable need to be replaced, this

must be carried out by our Authorised Service Centre.

- Do not let mains cables touch or come near the appliance door or the niche below the appliance, especially when it operates or the door is hot.
- The shock protection of live and insulated parts must be fastened in such a way that it cannot be removed without tools.
- Connect the mains plug to the mains socket only at the end of the installation. Make sure that there is access to the mains plug after the installation.
- If the mains socket is loose, do not connect the mains plug.
- Do not pull the mains cable to disconnect the appliance. Always pull the mains plug.
- Use only correct isolation devices: line protecting cut-outs, fuses (screw type fuses removed from the holder), earth leakage trips and contactors.
- The electrical installation must have an isolation device which lets you disconnect the appliance from the mains at all poles. The isolation device must have a contact opening width of minimum 3 mm.
- This appliance is supplied without a main plug and a main cable.

## 2.3 Use

### **WARNING!**

Risk of injury, burns and electric shock or explosion.

- Do not change the specification of this appliance.
- Make sure that the ventilation openings are not blocked.
- Do not let the appliance stay unattended during operation.
- Deactivate the appliance after each use.
- Be careful when you open the appliance door while the appliance is in operation. Hot air can release.
- Do not operate the appliance with wet hands or when it has contact with water.
- Do not apply pressure on the open door.
- Do not use the appliance as a work surface or as a storage surface.
- Open the appliance door carefully. The use of ingredients with alcohol can cause a mixture of alcohol and air.

- Do not let sparks or open flames to come in contact with the appliance when you open the door.
- Do not put flammable products or items that are wet with flammable products in, near or on the appliance.

 **WARNING!**

Risk of damage to the appliance.

- To prevent damage or discoloration to the enamel:
  - do not put ovenware or other objects in the appliance directly on the bottom.
  - do not put aluminium foil directly on the bottom of cavity of the appliance.
  - do not put water directly into the hot appliance.
  - do not keep moist dishes and food in the appliance after you finish the cooking.
  - be careful when you remove or install the accessories.
- Discoloration of the enamel or stainless steel has no effect on the performance of the appliance.
- Use a deep pan for moist cakes. Fruit juices cause stains that can be permanent.
- Always cook with the appliance door closed.
- If the appliance is installed behind a furniture panel (e.g. a door) make sure the door is never closed when the appliance operates. Heat and moisture can build up behind a closed furniture panel and cause subsequent damage to the appliance, the housing unit or the floor. Do not close the furniture panel until the appliance has cooled down completely after use.

## 2.4 Care and cleaning

 **WARNING!**

Risk of injury, fire, or damage to the appliance.

- Before maintenance, deactivate the appliance and disconnect the mains plug from the mains socket.
- Make sure the appliance is cold. There is the risk that the glass panels can break.

- Replace immediately the door glass panels when they are damaged. Contact the Authorised Service Centre.
- Be careful when you remove the door from the appliance. The door is heavy!
- Clean regularly the appliance to prevent the deterioration of the surface material.
- Clean the appliance with a moist soft cloth. Use only neutral detergents. Do not use abrasive products, abrasive cleaning pads, solvents or metal objects.
- If you use an oven spray, follow the safety instructions on its packaging.
- Do not clean the catalytic enamel with detergents.

## 2.5 Internal lighting

 **WARNING!**

Risk of electric shock.

- Concerning the lamp(s) inside this product and spare part lamps sold separately: These lamps are intended to withstand extreme physical conditions in household appliances, such as temperature, vibration, humidity, or are intended to signal information about the operational status of the appliance. They are not intended to be used in other applications and are not suitable for household room illumination.
- This product contains a light source of energy efficiency class G.
- Use only lamps with the same specifications.

## 2.6 Service

- To repair the appliance contact the Authorised Service Centre.
- Use original spare parts only.

## 2.7 Disposal

 **WARNING!**

Risk of injury or suffocation.

- Contact your municipal authority for information on how to dispose of the appliance.
- Disconnect the appliance from the mains supply.

- Cut off the mains electrical cable close to the appliance and dispose of it.

- Remove the door catch to prevent children or pets from becoming trapped in the appliance.

## 3. PRODUCT DESCRIPTION

### 3.1 General overview

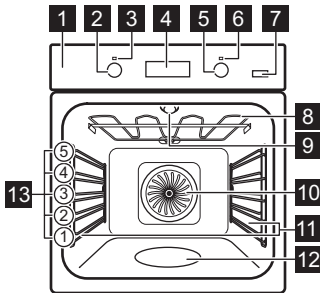

- 1 Control panel
- 2 Knob for the heating functions
- 3 Power lamp / symbol
- 4 Display
- 5 Control knob (for the temperature)
- 6 Temperature indicator / symbol
- 7 Plus Steam
- 8 Heating element
- 9 Lamp
- 10 Fan
- 11 Shelf support, removable
- 12 Cavity embossment
- 13 Shelf positions

### 3.2 Accessories

#### Wire shelf

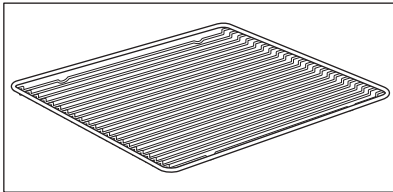

For cookware, cake tins, roasts.

#### Baking tray

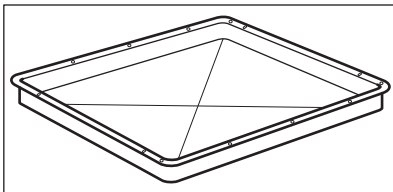

For cakes and biscuits.

#### Grill- / Roasting pan

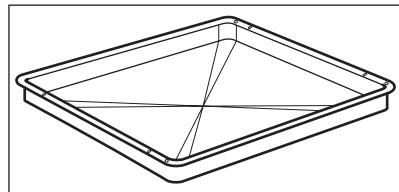

To bake and roast or as a pan to collect fat.

## 4. CONTROL PANEL

### 4.1 Retractable knobs

To use the appliance press the knob. The knob comes out.

### 4.2 Sensor fields / Buttons

—	To set the time.
🕒	To set a clock function.
+	To set the time.

### 4.3 Display

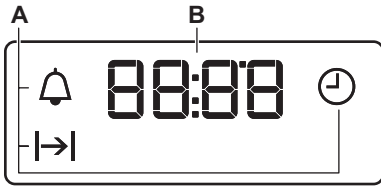

- A. Clock functions
- B. Timer

## 5. BEFORE FIRST USE

### ⚠️ WARNING!

Refer to Safety chapters.

### 5.1 Before first use



The oven can emit an odour and smoke during preheating. Make sure that the room is ventilated.

		
Step 1	Step 2	Step 3
Set the clock	Clean the oven	Preheat the empty oven



1.  - press to set the time. After approximately 5 sec., the flashing stops and the display shows the time.

1. Remove all accessories and removable shelf supports from the oven.
2. Clean the oven and the accessories only with a microfibre cloth, warm water and a mild detergent.

1. Set the maximum temperature for the function: . Time: 1 h.
2. Set the maximum temperature for the function: . Time: 15 min.

Turn off the oven and wait until it is cold. Place the accessories and the removable shelf supports in the oven.

## 6. DAILY USE

### **WARNING!**

Refer to Safety chapters.

### 6.1 How to set: Heating function

- |               |   |
|---------------|---|
| <b>Step 1</b> | Turn the knob for the heating functions to select a heating function.           |
| <b>Step 2</b> | Turn the control knob to select the temperature.                                |
| <b>Step 3</b> | When the cooking ends, turn the knobs to the off position to turn off the oven. |



### 6.2 Setting the function: True Fan Cooking PLUS

### **WARNING!**



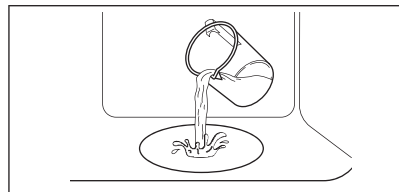





Risk of burns and damage to the appliance.



- |               |  |
|---------------|--|
| <b>Step 1</b> | Make sure that the oven is cold.   |
| <b>Step 2</b> | Fill the cavity embossment with tap water.<br> The maximum capacity of the cavity embossment is 250 ml. Do not refill the cavity embossment during cooking or when the oven is hot. |



- |               |   |
|---------------|---|
| <b>Step 3</b> | Set the function:   . |
| <b>Step 4</b> | Turn the control knob for the temperature to set temperature.   |
| <b>Step 5</b> | Preheat the empty oven for 10 min to create humidity.   |
| <b>Step 6</b> | Put food in the oven.<br>Refer to "Hints and tips" chapter.<br>Do not open the oven door during cooking.  |
| <b>Step 7</b> | Turn the knob for the heating functions to the off position to turn off the oven.   |
| <b>Step 8</b> | After the function ends, carefully open the door. Released humidity can cause burns.  |
| <b>Step 9</b> | Make sure that the oven is cold. Remove the remaining water from the cavity embossment.   |

## 6.3 Heating functions

Heating function	Application
 Off position	The oven is off.
 Light	To turn on the lamp.
 True Fan Cooking / True Fan Cooking PLUS	To bake on up to three shelf positions at the same time and to dry food. Set the temperature 20 - 40 °C lower than for Conventional Cooking. To add humidity during the cooking. To get the right colour and crispy crust during baking. To give more juiciness during reheating.
 Pizza Function	To bake pizza. To make intensive browning and a crispy bottom.
 Conventional Cooking	To bake and roast food on one shelf position.
 Bottom Heat	To bake cakes with crispy bottom and to preserve food.
 Defrost	To defrost food (vegetables and fruit). The defrosting time depends on the amount and size of the frozen food.
 Moist Fan Baking	This function is designed to save energy during cooking. When you use this function, the temperature in the cavity may differ from the set temperature. The residual heat is used. The heating power may be reduced. For more information refer to "Daily Use" chapter, Notes on: Moist Fan Baking.

Heating function	Application
 Grill	To grill thin pieces of food and to toast bread.
 Turbo Grilling	To roast large meat joints or poultry with bones on one shelf position. To make gratins and to brown.



The lamp may turn off automatically at a temperature below 60 °C during some oven functions.

## 6.4 Notes on: Moist Fan Baking



This function was used to comply with the energy efficiency class and ecodesign requirements (according to EU 65/2014 and EU 66/2014). Tests according to: IEC/EN 60350-1.

The oven door should be closed during cooking so that the function is not interrupted and the oven operates with the highest energy efficiency possible.

For the cooking instructions refer to "Hints and tips" chapter, Moist Fan Baking. For general energy saving recommendations refer to "Energy Efficiency" chapter, Energy Saving.

## 7. CLOCK FUNCTIONS

### 7.1 Clock functions

Clock function	Application
 Time of Day	To set, change or check the time of day.
 Duration	To set how long the oven works.
 Minute Minder	To set a countdown. This function has no effect on the operation of the oven. You can set this function at any time, also when the oven is off.



### 7.2 How to set: Clock functions

#### How to set: Time of Day

 - flashes when you connect the oven to the electrical supply, when there was a power cut or when the timer is not set.

**+**, **-** - press to set the time.  
After approximately 5 sec., the flashing stops and the display shows the time.

#### How to change: Time of Day



**Step 1**  - press repeatedly to change the time of day.  - starts to flash.

**Step 2** **+**, **-** - press to set the time.  
After approximately 5 sec., the flashing stops and the display shows the time.

#### How to set: Duration

**Step 1** Set an oven function and the temperature.

**Step 2**  - press repeatedly.  - starts to flash.

**Step 3** **+**, **-** - press to set the duration.  
The display shows:   
 - flashes when the set time ends. The signal sounds and the oven turns off.

**Step 4** Press any button to stop the signal.

**Step 5** Turn the knobs to the off position.

#### How to set: Minute Minder

**Step 1**  - press repeatedly.  - starts to flash.

### How to set: Minute Minder

**Step 2** **+**, **-** - press to set the time.  
The function starts automatically after 5 sec.  
When the set time ends, the signal sounds.

**Step 3** Press any button to stop the signal.

**Step 4** Turn the knobs to the off position.

### How to cancel: Clock functions

**Step 1**  - press repeatedly until the clock function symbol starts to flash.

**Step 2** Press and hold: **-**.  
The clock function turns off after few seconds.

## 8. USING THE ACCESSORIES

### **WARNING!**

Refer to Safety chapters.

### 8.1 Inserting accessories

A small indentation at the top increases safety. The indentations are also anti-tip

devices. The high rim around the shelf prevents cookware from slipping of the shelf.

#### **Wire shelf:**

Push the shelf between the guide bars of the shelf support.

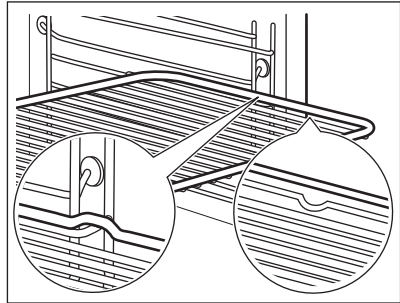

**Baking tray / Deep pan:**

Push the tray between the guide bars of the shelf support.

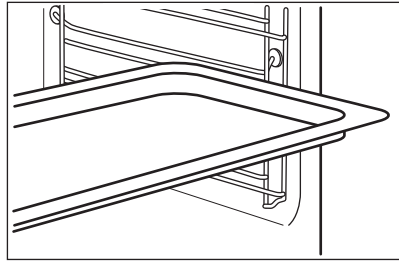

## 9. ADDITIONAL FUNCTIONS

### 9.1 Cooling fan

When the appliance operates, the cooling fan turns on automatically to keep the surfaces of

the appliance cool. If you turn off the appliance, the cooling fan can continue to operate until the appliance cools down.

## 10. HINTS AND TIPS



Refer to Safety chapters.

### 10.1 Cooking recommendations



The temperature and cooking times in the tables are guidelines only. They depend on the recipes and the quality and quantity of the ingredients used.

Your appliance may bake or roast differently to the appliance you had before. The hints below show recommended settings for temperature, cooking time and shelf position for specific types of the food.

If you cannot find the settings for a special recipe, look for the similar one.

### 10.2 True Fan Cooking PLUS

Use the second shelf position.

Use a baking tray.



**CAKES / PASTRIES / BREADS**



(ml)



(°C)



(min)

Cookies / Scones / Croissants	100	150 - 180	10 - 20
Focaccia	100	200 - 210	10 - 20
Pizza	100	230	10 - 20
Bread rolls	100	200	20 - 25

**CAKES / PASTRIES / BREADS****(ml)****(°C)****(min)**

Bread

100

180

35 - 40

Plum cake / Apple pie / Cinnamon rolls, baked in a cake mould

100 - 150

160 - 180

30 - 60

Use 150 ml of water unless specified otherwise.

**FROZEN READY MEALS****(°C)****(min)**

Pizza

200 - 210

10 - 20

Croissants

170 - 180

15 - 25

Lasagne, use 200 ml

180 - 200

35 - 50

Use 100 ml of water.

Set the temperature to 110 °C.

**FOOD REGENERATION****(min)**

Bread rolls

10 - 20

Bread

15 - 25

Focaccia

15 - 25

Meat

15 - 25

Pasta

15 - 25

Pizza

15 - 25

Rice

15 - 25

Vegetables

15 - 25

Use 200 ml of water.

Use a glass baking dish.

**ROASTING****(°C)****(min)**

Roast beef

200

50 - 60

Chicken

210

60 - 80

### 10.3 Baking

For the first baking, use the lower temperature.

You can extend the baking time by 10 – 15 minutes if you bake cakes on more than one shelf position.

Cakes and pastries at different heights do not always brown equally. There is no need to





change the temperature setting if an unequal browning occurs. The differences equalize during baking.

Trays in the oven can distort during baking. When the trays are cold again, the distortions disappear.

### 10.4 Tips on baking

Baking results	Possible cause	Remedy
The bottom of the cake is not baked sufficiently.	The shelf position is incorrect.	Put the cake on a lower shelf.
The cake sinks and becomes soggy or streaky.	The oven temperature is too high.	Next time set slightly lower oven temperature.
	The oven temperature is too high and the baking time is too short.	Next time set a longer baking time and lower oven temperature.
The cake is too dry.	The oven temperature is too low.	Next time set higher oven temperature.
	The baking time is too long.	Next time set shorter baking time.
The cake bakes unevenly.	The oven temperature is too high and the baking time is too short.	Next time set a longer baking time and lower oven temperature.
	The cake batter is not evenly distributed.	Next time spread the cake batter evenly on the baking tray.
The cake is not ready in the baking time specified in a recipe.	The oven temperature is too low.	Next time set a slightly higher oven temperature.



### 10.5 Baking on one shelf level

 BAKING IN TINS		 (°C)	 (min)	
Flan base - short pastry, preheat the empty oven	True Fan Cooking	170 - 180	10 - 25	2
Flan base - sponge cake mixture	True Fan Cooking	150 - 170	20 - 25	2
Ring cake / Brioche	True Fan Cooking	150 - 160	50 - 70	1
Madeira cake / Fruit cakes	True Fan Cooking	140 - 160	70 - 90	1
Cheesecake	Conventional Cooking	170 - 190	60 - 90	1

Use the third shelf position.

Use the function: True Fan Cooking.





Use a baking tray.

 <b>CAKES / PASTRIES / BREADS</b>	 <b>(°C)</b>	 <b>(min)</b>
Cake with crumble topping	150 - 160	20 - 40
Fruit flans (made of yeast dough / sponge cake mixture), use a deep pan	150	35 - 55
Fruit flans made of short pastry	160 - 170	40 - 80





Preheat the empty oven.

Use the function: Conventional Cooking.





Use a baking tray.

 <b>CAKES / PASTRIES / BREADS</b>	 <b>(°C)</b>	 <b>(min)</b>	
Swiss roll	180 - 200	10 - 20	3
Rye bread:	first: 230	20	1
	then: 160 - 180	30 - 60	
Buttered almond cake / Sugar cakes	190 - 210	20 - 30	3
Cream puffs / Eclairs	190 - 210	20 - 35	3
Plaited bread / Bread crown	170 - 190	30 - 40	3
Fruit flans (made of yeast dough / sponge cake mixture), use a deep pan	170	35 - 55	3
Yeast cakes with delicate toppings (e.g. quark, cream, custard)	160 - 180	40 - 80	3
Christstollen	160 - 180	50 - 70	2

Use the third shelf position.





 <b>BISCUITS</b>		 <b>(°C)</b>	 <b>(min)</b>
Short pastry biscuits	True Fan Cooking	150 - 160	10 - 20
Rolls, preheat the empty oven	True Fan Cooking	160	10 - 25



 BISCUITS		 (°C)	 (min)
Biscuits made of sponge cake mixture	True Fan Cooking	150 - 160	15 - 20
Puff pastries, preheat the empty oven	True Fan Cooking	170 - 180	20 - 30
Biscuits made of yeast dough	True Fan Cooking	150 - 160	20 - 40
Macaroons	True Fan Cooking	100 - 120	30 - 50
Pastries made of egg white / Meringues	True Fan Cooking	80 - 100	120 - 150
Rolls, preheat the empty oven	Conventional Cooking	190 - 210	10 - 25

## 10.6 Bakes and gratins





Use the first shelf position.





		 (°C)	 (min)
Baguettes topped with melted cheese	True Fan Cooking	160 - 170	15 - 30
Vegetables au gratin, preheat the empty oven	Turbo Grilling	160 - 170	15 - 30
Lasagne	Conventional Cooking	180 - 200	25 - 40
Fish bakes	Conventional Cooking	180 - 200	30 - 60
Stuffed vegetables	True Fan Cooking	160 - 170	30 - 60
Sweet bakes	Conventional Cooking	180 - 200	40 - 60
Pasta bake	Conventional Cooking	180 - 200	45 - 60

## 10.7 Multilevel Baking

Use the function: True Fan Cooking.

Use the baking trays.

 CAKES / PASTRIES	 (°C)	 (min)	 2 positions
Cream puffs / Eclairs, preheat the empty oven	160 - 180	25 - 45	1 / 4
Dry streusel cake	150 - 160	30 - 45	1 / 4

 BIS- CUITS / SMALL CAKES / PAS- TRIES / ROLLS	 (°C)	 (min)		
			2 positions	3 positions
Rolls	180	20 - 30	1 / 4	-
Short pastry biscuits	150 - 160	20 - 40	1 / 4	1 / 3 / 5
Biscuits made of sponge cake mixture	160 - 170	25 - 40	1 / 4	-
Puff pastries, pre-heat the empty oven	170 - 180	30 - 50	1 / 4	-
Biscuits made of yeast dough	160 - 170	30 - 60	1 / 4	-
Macaroons	100 - 120	40 - 80	1 / 4	-
Biscuits made of egg white / Meringues	80 - 100	130 - 170	1 / 4	-

## 10.8 Tips on Roasting

Use heat-resistant ovenware.

Roast lean meat covered (you can use aluminium foil).

Roast large meat joints directly in the tray.

Put some water in the tray to prevent dripping fat from burning.

Turn the roast after 1/2 - 2/3 of the cooking time.







Roast meat and fish in large pieces (1 kg or more).

If level one is suggested put the food directly on the baking tray

Baste meat joints with their own juice several times during roasting.

## 10.9 Roasting

Use the first shelf position.

 BEEF				 (°C)	 (min)
Pot roast	1 - 1.5 kg	Conventional Cooking	230	120 - 150	
Roast beef or fillet, rare, preheat the empty oven	per cm of thickness	Turbo Grilling	190 - 200	5 - 6	
Roast beef or fillet, medium, preheat the empty oven	per cm of thickness	Turbo Grilling	180 - 190	6 - 8	
Roast beef or fillet, well done, preheat the empty oven	per cm of thickness	Turbo Grilling	170 - 180	8 - 10	



## VEAL



Use the function: Turbo Grilling.



(kg)



(°C)



(min)

Roast veal

1

160 - 180

90 - 120

Veal knuckle

1.5 - 2

160 - 180

120 - 150



## LAMB



Use the function: Turbo Grilling.



(kg)



(°C)



(min)

Lamb leg / Roast lamb

1 - 1.5

150 - 170

100 - 120

Lamb saddle

1 - 1.5

160 - 180

40 - 60



## GAME



Use the function: Conventional Cooking.



(kg)



(°C)



(min)

Saddle / Hare leg, preheat the empty oven

up to 1

230

30 - 40

Venison saddle

1.5 - 2

210 - 220

35 - 40

Haunch of venison

1.5 - 2

180 - 200

60 - 90



## POULTRY



Use the function: Turbo Grilling.



(kg)



(°C)



(min)

	(kg)	(°C)	(min)
Poultry, portions	0.2 - 0.25 each	200 - 220	30 - 50
Chicken, half	0.4 - 0.5 each	190 - 210	35 - 50
Chicken, poulard	1 - 1.5	190 - 210	50 - 70
Duck	1.5 - 2	180 - 200	80 - 100
Goose	3.5 - 5	160 - 180	120 - 180
Turkey	2.5 - 3.5	160 - 180	120 - 150
Turkey	4 - 6	140 - 160	150 - 240



## FISH (STEAMED)



Use the function: Conventional Cooking.



(kg)



(°C)



(min)

Whole fish	1 - 1.5	210 - 220	40 - 60
------------	---------	-----------	---------

## 10.10 Crispy baking with: Pizza Function



### PIZZA



Use the first shelf position.



(°C)



(min)

Tarts	180 - 200	40 - 55
Spinach flan	160 - 180	45 - 60
Cheesecake	140 - 160	60 - 90



### PIZZA



Use the first shelf position.



(°C)



(min)

Vegetable pie	160 - 180	50 - 60
---------------	-----------	---------



## PIZZA



Preheat the empty oven before cooking.



Use the second shelf position.



(°C)



(min)

Pizza, thin crust, use a deep pan 200 - 230 15 - 20

Pizza, thick crust 180 - 200 20 - 30

Unleavened bread 230 - 250 10 - 20

Puff pastry flan 160 - 180 45 - 55



## PIZZA



Preheat the empty oven before cooking.



Use the second shelf position.



(°C)



(min)

Flammkuchen 230 - 250 12 - 20

Pierogi 180 - 200 15 - 25

### 10.11 Grill

Preheat the empty oven before cooking.

Grill only thin pieces of meat or fish.

Put a pan on the first shelf position to collect fat.



## GRILL



Use the function: Grill



(°C)



(min)  
1st side



(min)  
2nd side



Roast beef 210 - 230 30 - 40 30 - 40 2

Beef fillet 230 20 - 30 20 - 30 3

Veal loin 210 - 230 30 - 40 30 - 40 2

Lamb saddle 210 - 230 25 - 35 20 - 25 3

Whole fish, 0.5 kg - 1 kg 210 - 230 15 - 30 15 - 30 3 / 4

## 10.12 Frozen Foods



### DEFROSTING



Use the function: True Fan Cooking.



(°C)



(min)



	(°C)	(min)	
Pizza, frozen	200 - 220	15 - 25	2
Pizza American, frozen	190 - 210	20 - 25	2
Pizza, chilled	210 - 230	13 - 25	2
Pizza snacks, frozen	180 - 200	15 - 30	2
French fries, thin	200 - 220	20 - 30	3
French fries, thick	200 - 220	25 - 35	3
Wedges / Croquettes	220 - 230	20 - 35	3
Hash browns	210 - 230	20 - 30	3
Lasagne / Cannelloni, fresh	170 - 190	35 - 45	2
Lasagne / Cannelloni, frozen	160 - 180	40 - 60	2
Baked cheese	170 - 190	20 - 30	3
Chicken wings	190 - 210	20 - 30	2

## 10.13 Defrost

Remove the food packaging and put the food on a plate.

Do not cover the food, as this can extend the defrost time.

Use the first shelf position.

For large portions of food place an upturned empty plate on the bottom of the oven cavity. Put the food in a deep dish and set it on top of the plate inside the oven. Remove the shelf supports if necessary.



(kg)







(min)  
Defrosting time



(min)  
Further defrosting time



	(kg)	(min) Defrosting time	(min) Further defrosting time	
Chicken	1	100 - 140	20 - 30	Turn halfway through.
Meat	1	100 - 140	20 - 30	Turn halfway through.
Trout	0.15	25 - 35	10 - 15	-
Strawberries	0.3	30 - 40	10 - 20	-

	 (kg)	 (min) Defrosting time	 (min) Further defrosting time	
Butter	0.25	30 - 40	10 - 15	-
Cream	2 x 0.2	80 - 100	10 - 15	Whip the cream when still slightly frozen in places.
Gateau	1.4	60	60	-

## 10.14 Preserving

Use the function Bottom Heat.

Use only preserve jars of the same dimensions available on the market.

Do not use jars with twist-off and bayonet type lids or metal tins.

Use the first shelf position.

Put no more than six one-litre preserve jars on the baking tray.



Fill the jars equally and close with a clamp.



The jars cannot touch each other.



Put approximately 1/2 litre of water into the baking tray to give sufficient moisture in the oven.

When the liquid in the jars starts to simmer (after approximately 35 - 60 minutes with one-litre jars), stop the oven or decrease the temperature to 100 °C (see the table).

Set the temperature to 160 - 170 °C.

 SOFT FRUIT	 (min) Cooking time until simmering
Strawberries / Blueberries / Raspberries / Ripe gooseberries	35 - 45

 STONE FRUIT	 (min) Cooking time until simmering	 (min) Continue to cook at 100 °C
Peaches / Quinces / Plums	35 - 45	10 - 15

 VEG-ETABLES	 (min) Cooking time until simmering	 (min) Continue to cook at 100 °C
Carrots	50 - 60	5 - 10
Cucumbers	50 - 60	-
Mixed pickles	50 - 60	5 - 10
Kohlrabi / Peas / Asparagus	50 - 60	15 - 20



## 10.15 Dehydrating - True Fan Cooking

Cover trays with grease proof paper or baking parchment.



For a better result, stop the oven halfway through the drying time, open the door and let it cool down for one night to complete the drying.

For 1 tray use the third shelf position.

For 2 trays use the first and fourth shelf position.



 VEGETA- BLES	 (°C)	 (h)
Beans	60 - 70	6 - 8
Peppers	60 - 70	5 - 6
Vegetables for soup	60 - 70	5 - 6
Mushrooms	50 - 60	6 - 8
Herbs	40 - 50	2 - 3

Set the temperature to 60 - 70 °C.

 FRUIT	 (h)
Plums	8 - 10
Apricots	8 - 10
Apple slices	6 - 8
Pears	6 - 9



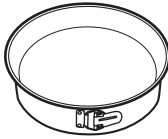

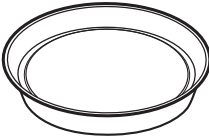
## 10.16 Moist Fan Baking - recommended accessories

Use the dark and non-reflective tins and containers. They have better heat absorption than the light colour and reflective dishes.

			
<b>Pizza pan</b>	<b>Baking dish</b>	<b>Ramekins</b>	<b>Flan base tin</b>
Dark, non-reflective 28 cm diameter	Dark, non-reflective 26 cm diameter	Ceramic 8 cm diameter, 5 cm height	Dark, non-reflective 28 cm diameter

## 10.17 Moist Fan Baking

For the best results follow suggestions listed in the table below.





	 (°C)	 (min)	
Bread sticks, 0.5 kg in total	190 - 200	50 - 60	3
Baked scallops in shells	180 - 200	30 - 40	4
Whole fish in salt, 0.3 - 0.5 kg	190 - 200	45 - 50	4
Whole fish in parchment, 0.3 - 0.5 kg	190 - 200	50 - 60	3
Amaretti (20; 0.5 kg in total)	170 - 180	40 - 50	3
Apple crumble	190 - 200	50 - 60	4
Chocolate muffins (20; 0.5 kg in total)	160 - 170	35 - 45	3

## 10.18 Information for test institutes

Tests according to: EN 60350, IEC 60350.







## Baking on one level - baking in tins





		 °C	 min	
Fatless sponge cake	True Fan Cooking	160	45 - 60	2
Fatless sponge cake	Conventional Cooking	160	45 - 60	2
Apple pie, 2 tins Ø20 cm	True Fan Cooking	160	55 - 65	2
Apple pie, 2 tins Ø20 cm	Conventional Cooking	180	55 - 65	1
Short bread	True Fan Cooking	140	25 - 35	2
Short bread	Conventional Cooking	140	25 - 35	2

## Baking on one level - biscuits

Use the third shelf position.

		 °C	 min
Small cakes, 20 per tray, preheat the empty oven	True Fan Cooking	150	20 - 30
Small cakes, 20 per tray, preheat the empty oven	Conventional Cooking	170	20 - 30





## Multilevel baking - biscuits

		 °C	 min	
Short bread	True Fan Cooking	140	25 - 45	2 / 4
Small cakes, 20 per tray, pre-heat the empty oven	True Fan Cooking	150	25 - 35	1 / 4
Fatless sponge cake	True Fan Cooking	160	45 - 55	2 / 4
Apple pie, 1 tin per grid (Ø 20 cm)	True Fan Cooking	160	55 - 65	2 / 4

## Grill

Preheat the empty oven for 5 minutes.

Grill with the maximum temperature setting.

		 min	
Toast	Grill	1 - 2	5
Beef steak, turn halfway through	Grill	24 - 30	4

## 11. CARE AND CLEANING

### **WARNING!**

Refer to Safety chapters.

### 11.1 Notes on cleaning



#### Cleaning Agents

Clean the front of the appliance only with a microfibre cloth with warm water and a mild detergent.

Use a cleaning solution to clean metal surfaces.

Clean stains with a mild detergent. Do not apply it on the catalytic surfaces.



#### Everyday Use

Clean the cavity after each use. Fat accumulation or other residue may cause fire.

Do not store the food in the appliance for longer than 20 minutes. Dry the cavity only with a microfibre cloth after each use.



#### Accessories

Clean all accessories after each use and let them dry. Use only a microfibre cloth with warm water and a mild detergent. Do not clean the accessories in a dishwasher.

Do not clean the non-stick accessories using abrasive cleaner or sharp-edged objects.

### 11.2 How to clean: Cavity embossment

Clean the cavity embossment to remove limestone residue after cooking with steam.

Step 1	Step 2	Step 3
Pour: 250 ml of white vinegar into the cavity embossment. Use maximum 6% vinegar without any additives.	Let the vinegar dissolve the limestone residue at the ambient temperature for 30 minutes.	Clean the cavity with warm water and a soft cloth.

For the function: True Fan Cooking PLUS clean the oven for every 5 - 10 cooking cycles.

### 11.3 How to remove: Shelf supports

Remove the shelf supports to clean the oven.

**Step 1** Turn off the oven and wait until it is cold.

**Step 2** Pull the front of the shelf support away from the side wall.

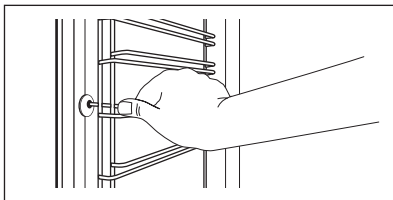

**Step 3** Pull the rear end of the shelf support away from the side wall and remove it.

**Step 4** Install the shelf supports in the opposite sequence.

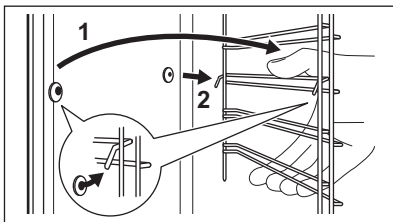

## 11.4 How to use: Catalytic cleaning

The cavity is coated with catalytic enamel. It absorbs fat during catalysis.

Spots or discolouration of the catalytic coating have no effect on the cleaning.

### Before the catalytic cleaning

Turn off the oven and wait until it is cold.

Remove all accessories and removable shelf supports.

Clean the oven floor and the inner door glass with warm water, soft cloth and mild detergent.

### Clean the oven with catalytic cleaning

#### Step 1

Set the function and the oven temperature:  250 °C  
Duration: 1 h

#### Step 2

After cleaning, turn the knob for the oven functions to the off position.

#### Step 3

When the oven is cold, clean the cavity with a wet soft cloth.

## 11.5 How to remove and install: Door

You can remove the door and the internal glass panels to clean it. The number of glass panels is different for different models.

### **WARNING!**

The door is heavy.

### **CAUTION!**

Carefully handle the glass, especially around the edges of the front panel. The glass can break.

**Step 1** Fully open the door.

**Step 2** Lift and press the clamping levers (A) on the two door hinges.

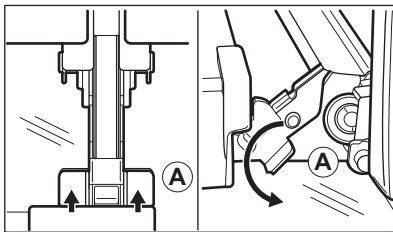

**Step 3** Close the oven door to the first opening position (approximately 70° angle). Hold the door at both sides and pull it away from the oven at an upwards angle. Put the door with the outer side down on a soft cloth on a stable surface.

**Step 4** Hold the door trim (B) on the top edge of the door at the two sides and push inwards to release the clip seal.

**Step 5** Pull the door trim to the front to remove it.

**Step 6** Hold the door glass panels on their top edge one by one and pull them up out of the guide.

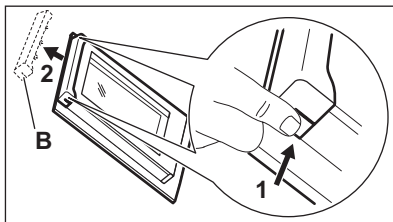

**Step 7** Clean the glass panel with water and soap. Dry the glass panel carefully. Do not clean the glass panels in the dishwasher.

**Step 8** After cleaning, do the above steps in the opposite sequence.

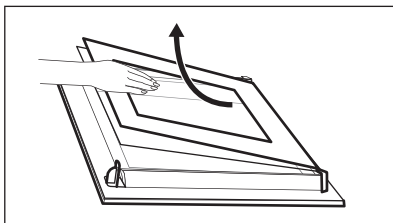

**Step 9** Install the smaller panel first, then the larger and the door. Make sure that the glasses are inserted in the correct position otherwise the surface of the door may overheat.

## 11.6 How to replace: Lamp

### **WARNING!**

Risk of electric shock.  
The lamp can be hot.

### Before you replace the lamp:

#### Step 1

Turn off the oven. Wait until the oven is cold.

#### Step 2

Disconnect the oven from the mains.

#### Step 3

Put a cloth on the bottom of the cavity.

## Top lamp

**Step 1** Turn the glass cover to remove it.

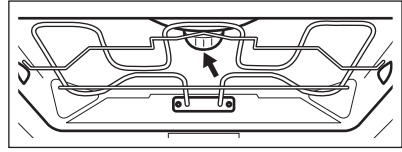

**Step 2** Clean the glass cover.

**Step 3** Replace the lamp with a suitable 300 °C heat-resistant lamp.

**Step 4** Install the glass cover.

## 12. TROUBLESHOOTING

### **⚠ WARNING!**

Refer to Safety chapters.

### 12.1 What to do if...

In any cases not included in this table please contact with an Authorised Service Centre.

Problem	Check if...
The oven does not heat up.	The fuse is blown.

Problem	Check if...
The display shows "12.00".	There was a power cut. Set the time of day.
The water leaks out of the cavity embossment.	There is too much water in the cavity embossment.
Unsatisfying cooking performance of the function: True Fan Cooking PLUS .	You filled the cavity embossment with water.
The lamp does not work.	The lamp is burnt out.

### 12.2 Service data

If you cannot find a solution to the problem yourself, contact your dealer or an Authorised Service Centre.

The necessary data for the service centre is on the rating plate. The rating plate is on the front frame of the appliance cavity. Do not remove the rating plate from the appliance cavity.

#### **We recommend that you write the data here:**

Model (MOD.) .....

Product number (PNC) .....

Serial number (S.N.) .....

## 13. ENERGY EFFICIENCY

### 13.1 Product Information and Product Information Sheet according to EU Ecodesign and Energy Labelling Regulations

Supplier's name	Electrolux
Model identification	KODEC60X 944184995
Energy Efficiency Index	95.3
Energy efficiency class	A
Energy consumption with a standard load, conventional mode	0.99 kWh/cycle
Energy consumption with a standard load, fan-forced mode	0.81 kWh/cycle
Number of cavities	1
Heat source	Electricity
Volume	71 l
Type of oven	Built-In Oven
Mass	33.0 kg

IEC/EN 60350-1 - Household electric cooking appliances - Part 1: Ranges, ovens, steam ovens and grills - Methods for measuring performance.

### 13.2 Energy saving



The appliance has features which help you save energy during everyday cooking.

Make sure that the appliance door is closed when the appliance operates. Do not open the appliance door too often during cooking. Keep the door gasket clean and make sure it is well fixed in its position.

Use metal cookware to improve energy saving.

When possible, do not preheat the appliance before cooking.

Keep breaks between baking as short as possible when you prepare a few dishes at one time.

#### **Cooking with fan**

When possible, use the cooking functions with fan to save energy.

#### **Residual heat**

When the cooking duration is longer than 30 min, reduce the appliance temperature to minimum 3 - 10 min before the end of cooking. The residual heat inside the appliance will continue to cook.

Use the residual heat to warm up other dishes.

#### **Keep food warm**

Choose the lowest possible temperature setting to use residual heat and keep a meal warm.

#### **Moist Fan Baking**

Function designed to save energy during cooking.

## 14. SAUDI ARABIA - CUSTOMER SERVICE

### **Further after-sales service agencies overseas**

In these countries our respective agents' own guarantee conditions are applicable. Please obtain further details directly.

### **First Distribution Company (FDC) Al Faisaliah Group**

#### **Main service center address:**

Al Khalidiya area – Port Street – Building name: Mussa 4

AL Dammam, Kingdom of Saudi Arabia.

#### **Postal address:**

P.O Box 2728 Riyadh 11461

Kingdom of Saudi Arabia

tel. + 966 11 243-9732

fax +966 11 243-9674

## 15. ENVIRONMENTAL CONCERNS

Recycle materials with the symbol . Put the packaging in relevant containers to recycle it. Help protect the environment and human health by recycling waste of electrical and electronic appliances. Do not dispose of

appliances marked with the symbol  with the household waste. Return the product to your local recycling facility or contact your municipal office.

CE



867361738-C-142023